



MESA LATERAL
SILVER

BRETON

POR
ESTÚDIO BRETON



MESA LATERAL
SILVER

BRETON

MESA LATERAL SILVER

42|52cm
17|21"

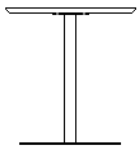

50cm
20"

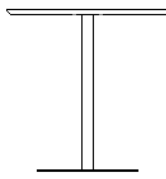

65cm
26"

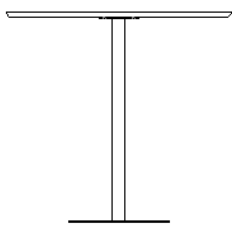

40cm
16|20"

50cm
20"

70|90cm
28|36"

40cm
16|20"

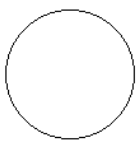

50cm
20"

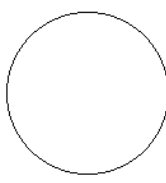

70|90cm
28|36"

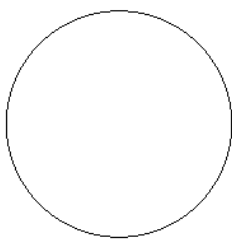

MESA LATERAL
SILVER

BRETON

BASE MESA LATERAL SILVER

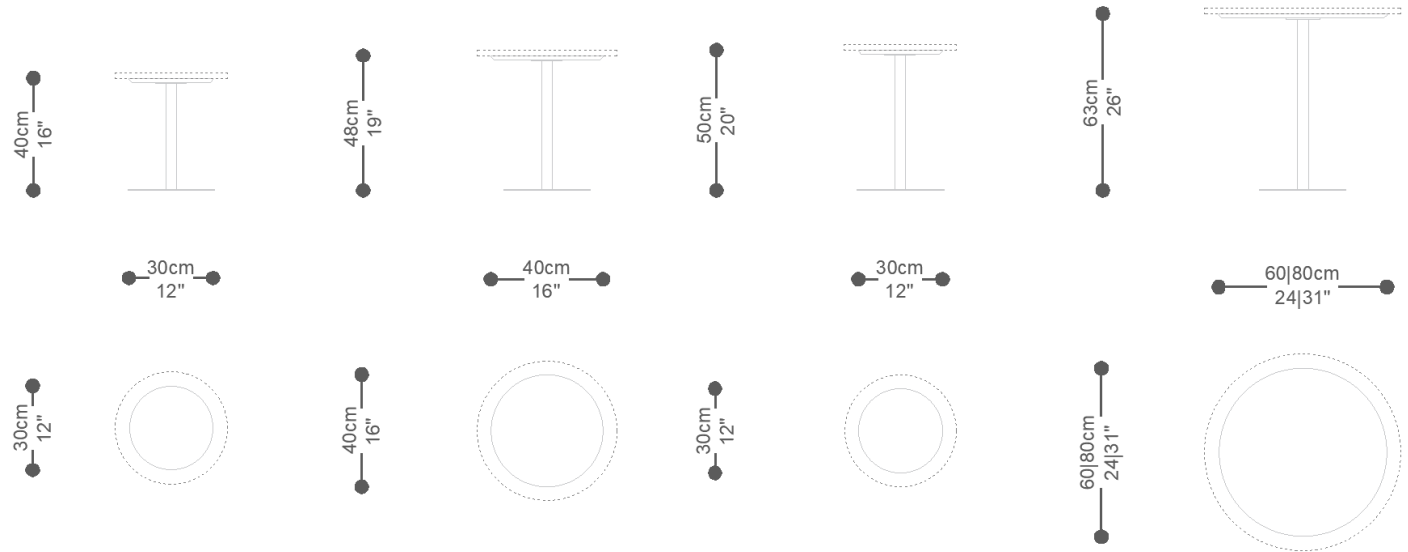

GARANTIA: 1 ano

EMBALAGEM: O produto é embalado em papelão, com bordas e cantos protegidos com cantoneiras de polietileno e envolto em filme plástico.

MESA LATERAL
SILVER

BRETON

Diferenciais:

- Com opção de base para tampo de mármore fornecido.



MESA LATERAL
SILVER

BRETON

 Estrutura de inox, pintado ou aplicação de verniz.
Tampo em MDF, com opção de ser laqueado, laminado ou mármore fornecido.

Medidas podem apresentar leves variações. Nos reservamos o direito de efetuar essas alterações sem consulta prévia.

MESA LATERAL
SILVER

BRETON